

S6064 Shadow Heat & Beat

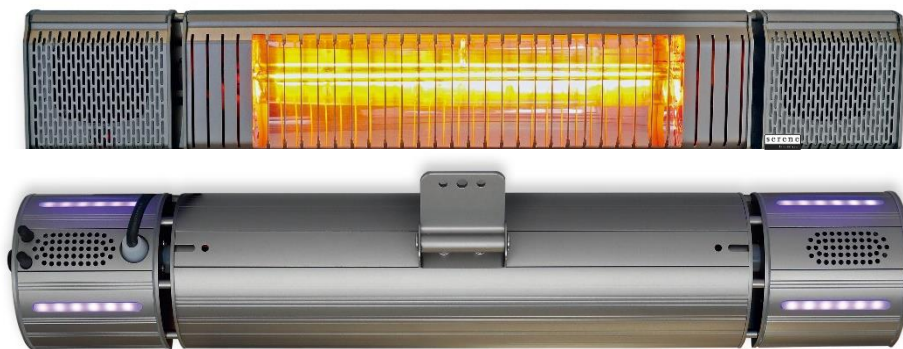

Infrared Bluetooth App Outdoor Heaters

Instructions & Operation Manual



S6064 Shadow Heat & Beat

Safety Information:



This appliance is not intended for use by persons (including children) with reduced physical, sensory or mental capabilities, or lack of experience and knowledge, unless they have been given supervision or instruction concerning use of the appliance by a person responsible for their safety.

When using any electrical appliance, safety precautions should always be observed. Read these instructions carefully, and retain for future reference.

When used by, or near, young children or infirm persons, supervision is necessary - young children should be supervised to ensure that they do not play with the appliance.

- Use this appliance only with the voltage specified on rating label.
- Do **NOT** use this appliance other than for its intended use.
- Do **NOT** touch hot surfaces or moving parts.
- Do **NOT** cover the grilles or place any object or material up against the unit, as this may block entry or exhaust of air.
- Do **NOT** probe any opening.

To ensure trouble free performance it is recommended that on a regular basis the unit be isolated from the power supply and a vacuum cleaner used to remove dust from the inlet and outlet grilles.

Caution:

When the heater is operated ensure the heater is not obstructed in any way. Ensure the heater can operate safely, should the heater switch on when the ambient temperature drops, or a timer activates the heater.

- Do **NOT** allow the supply cord to come into contact with heated surfaces during operation.
- Regulations require that electrical work be carried out by authorised persons. For your own safety and that of others, ensure this is done.
-  If the supply cord becomes damaged, it must be replaced by a qualified person, in order to avoid a hazard

Installation

For additional protection the installation of a residual current device (RCD) is recommended. (Refer to local electrical regulations)

Remove all packaging material (including anti-vibration pads on the lamp) and check the appliance, supply cord and the plug for signs of damage.

Pay attention to the mounting place and all mounting material. Ensure they are suitable and stable enough for mounting and holding the appliance on your chosen surface.

Before mounting, the minimum safe mounting distances and tilt angles shown in the figures must be strictly followed.

1. The distance between the bottom edge of the appliance and the floor must be at least 1.8 M.
2. There should be a distance of at least 0.2 M between the appliance and ceilings, roofs or other covers.
3. There should be a distance of at least 0.5 M at each side between the appliance and walls etc..
4. Recommended degree to mounting surface is 45°. **See figure 2.**
5. The max. swing degree is 90°

Fix the mounting bracket on the wall first. Ensuring that the area of installation is secure and firm.

Adjust the desired angle of radiation and tighten all screws. Check regularly as the screws' may loosen due to vibrations caused by wind or building movement.

Plug or hard wire into your power source.

Check to ensure that the heater is working.

Figure 1: Mounting bracket (wall bracket) and raw plugs provided. Connection from the wall to the infrared heater.

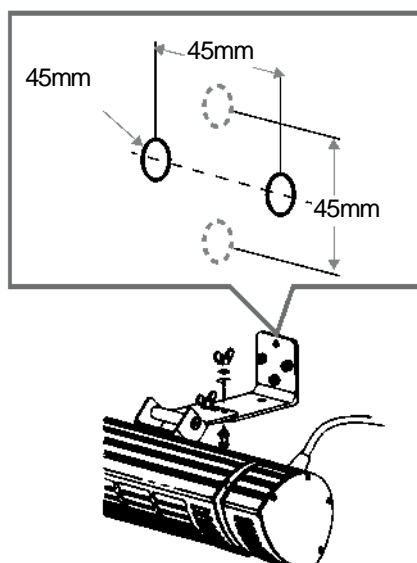
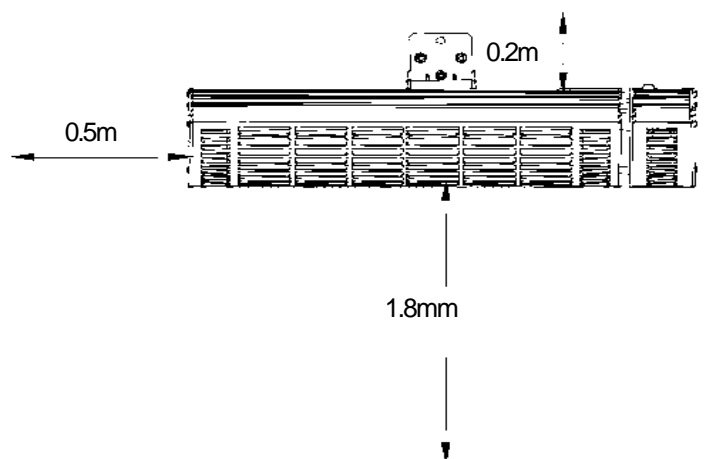
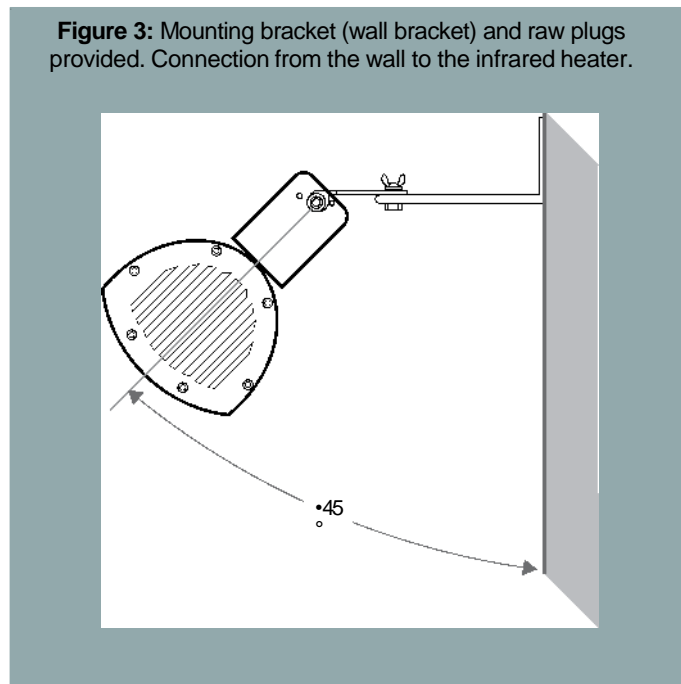

Figure 2: Minimum distances to floor, ceiling and wall.



Installation cont.

Figure 3: Mounting bracket (wall bracket) and raw plugs provided. Connection from the wall to the infrared heater.



Specifications:

Specification	S6064 Heat & Beat
Voltage (V)	220-240
Power consumption (W)	2000W
Dimensions W H D mm	740 x 130 x 175
Weight (kg)	3.9
Infrared receiving Angle	60°±5°
Control distance (m)	6
Speaker	2x3 watts weather resistant

Bluetooth App Operation

The free Serene Bluetooth App for this heater is available to download for either your iPhone, iPad or Android device. See back page for QR codes

The Serene 'Shadow' App will allow you to connect remotely to many S6066 heaters and control them independently. **Control functions include:**

- On/Off
- Variable heat output from 0 to 100%
- Timer with auto shut off
- Password connection to heaters
- Individual heater identification and control

To download, search for 'Serene Living' in your App store and add to your device.

Android



IOS



1. First Time Setup - Once the App is downloaded to your device follow the onscreen quick start guide for basic operation of the heater. **See below for detailed app operation guide.**

- Open the Serene living App
- When setting up the heater for the first time a pairing request will pop up tap Pair

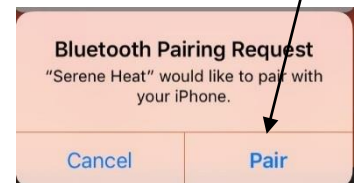

- Now a password window will pop up
- Enter an 8 character minimum password & tap ok

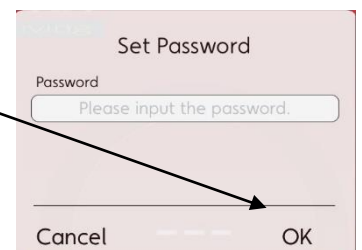

Bluetooth App Operation Cont.

2. Pairing the Heater :

- Ensure the Bluetooth function on your device is switched on & Open the Serene Living App
- Select the first tab and swipe down on the screen
- "Serene Heat" will then appear, swipe right to pair
- Heater is paired when switch turns green

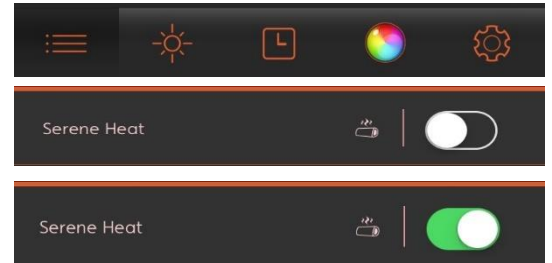

3. Adjusting the Heat :

- Select the second tab to open heat control
- Use the slider to control the heat level from 0% - 100%
- Click the power button to turn the heater on/off

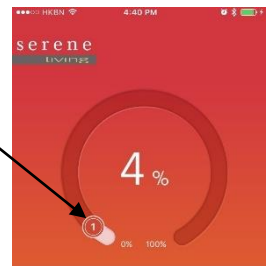

4. Setting the sleep Timer :

- Select the third tab to open timer control
- Swipe the switch right to turn timer on
- In the pop-up window select the desired time
- Tap OK to confirm the desired sleep time

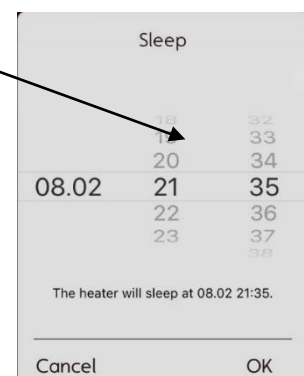
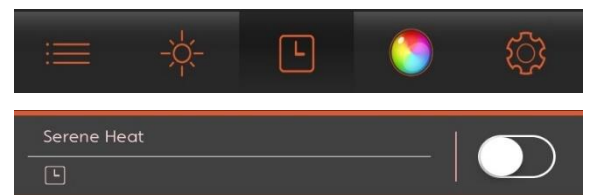

Bluetooth App Operation Cont.

5. Connecting to Serene Beat Speakers for the First Time : Once the **heater** is connected to your device via Bluetooth follow the below steps to connect the **speakers**

- On the Second Tab, click the music note

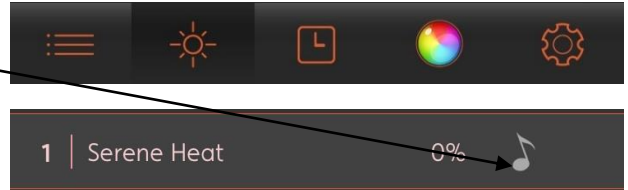

- The pairing screen will now appear click the Button to enter pairing mode (Button will turn orange when in pairing mode)
- Ensure the volume is set to high



- Now open your devices Bluetooth settings menu and a pairing request will pop-up
- Click Pair and **your now able to play Music via the Serene Beat Speakers**

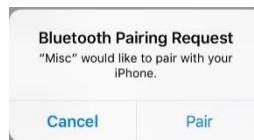

6. Connecting to Serene Beat Speakers next time :

- Once the devices are paired , simply open your devices Bluetooth menu and select "Serene Beat" to play music next time.



Bluetooth App Operation Cont.

7. Changing the Mood Lighting :

- Select the 4th Tab to access mood lighting
- Tap the colour palate that appears next to Serene Heat
- Select SMOOTH or BEAT buttons for Auto light changing modes
- Tap the light switch to turn the mood lights off
- Use the magnifying symbols to adjust brightness
- Use the colour wheel to select a custom colour
- Select a Colour and tap save to set it as a pre-set
- Tap pre-set to select from up to 8 pre-set colours

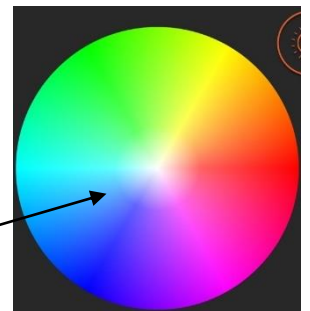
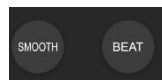
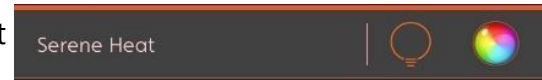





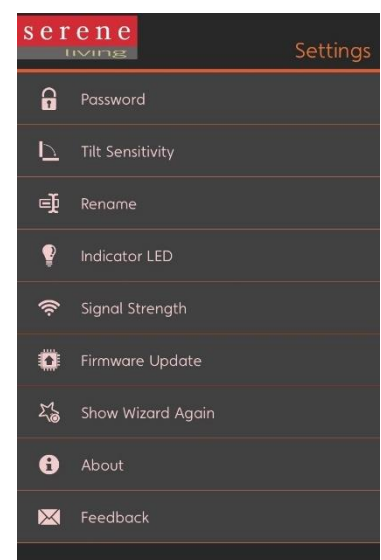

8. Changing Settings :

- Select the 5th tab to change settings
- Tap Password and select "Serene Heat" to change
 - Must be 8 Characters long
- Tap Rename to change the heater name
- To turn front LED off tap indicator LED



Heat & Beat Remote Control Operation



Button	Graphic	Feature
Increase Heat		Press to increase the heat level
Decrease Heat		Press to decrease the heat level
LED Lights On		Turns LED backlights on
LED Lights OFF		Turns LED backlights off
BT Music		Press to turn speakers on/off Hold to establish BT connection.
ON		To switch the heater on: Press ON. The patio heater has a soft start function of 33% power. 4 seconds after the heater has been turned on, it will automatically switch to the last heating level used. In case of the first-time use, after 4seconds the heater will automatically switch to 100% power.
OFF		To switch the heater off: Press OFF. The heater will switch to standby mode(the receiver indicator will light up).

Heater Controls – left end of Unit

- To rest hold rest button down for 10 seconds until indicator LED flashes
- Use the power switch to turn the unit on/off

Remote Control

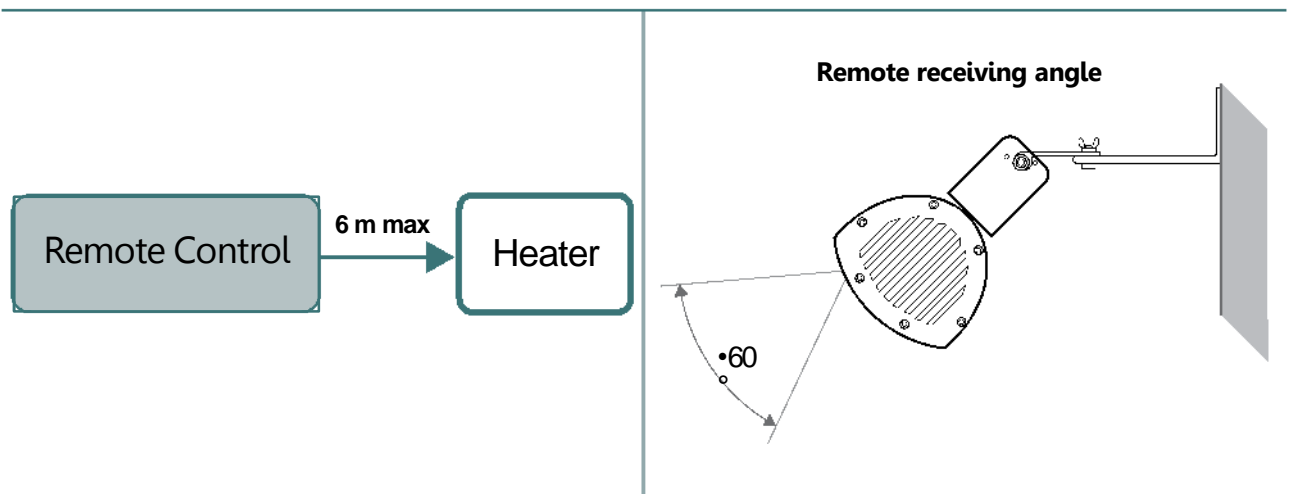

NOTE

Use 2 AAA.5V batteries in the remote control. Remove batteries when not use for long periods. The remote control function may not work if there is a barrier between the remote control and heater.

Cleaning And Maintenance

1. This appliance is manufactured from a robust and maintenance-free aluminum.
2. Before cleaning, remove the plug from the power outlet and wait until the appliance is sufficiently cooled off.
3. Wipe the appliance only with clean and lint-free cloth or a soft brush.
4. Never use abrasive cleaners, scrubbing brushes and chemical cleaners for cleaning!
5. You may use alcohol to clean the appliance.
6. To protect against electrical shock, do not immerse cord, plug, or any part of the appliance in water or other liquid.

Contacts:

HONG KONG

Head Office - Serene Industries Limited

t: +852 2325 3209

f: +852 2325 3166

e: info@serene-ind.com

w: www.serene-ind.com

Suite 1010, 15F, Block A, Alexander Industrial Building, 62 King Lam Street,
Cheung Sha Wan, Kowloon Hong Kong SAR

NEW ZEALAND

t: (+) 64 (3) 344 5550

f: 0800 437 264- Freefax

e: nzenquiry@serene-ind.com

w: www.serene-ind.com

PO BOX 33501, Barrington, Christchurch 8024

AUSTRALIA

t: + 61 (3) 8354 4133

f: + 61 (3) 9699 6422

fp: +1800 561 961- Freephone

e: enquiries@serene-australia.com

w: www.serene-australia.com

Suite 201 / 175B Stephen Street, Yarraville
Melbourne VIC 3013